

■ Product Pictures



- Lumileds LED, high luminous efficiency and long working life.
- High efficiency LED Driver, the wide range input voltage AC100-277V and AC200-480V.
- Cast aluminum cooling design, better cooling, light in weight, LED Tj < 85°C.
- Excellent Optics design, greatly improve the light utilization and evenness.
- Photocell Control Available (Option)



■ Product Applications

ACES LED FULL CUTOFF WALL PACK Lighting series can be widely used in indoor or outdoor lighting (Wet location) , like mechanical or electronic processing workshops, storage warehouses, steel mills, gas stations, toll booth, waiting rooms, the platforms of railway station , indoor stadiums and flower cultivating tents etc.

■ Structure Features

- Shell materials: Aluminum & PC .
- Finish: Dark Bronze/White
- Net weight: 2.90kgs (6.40 lbs) Unit: inch(mm)

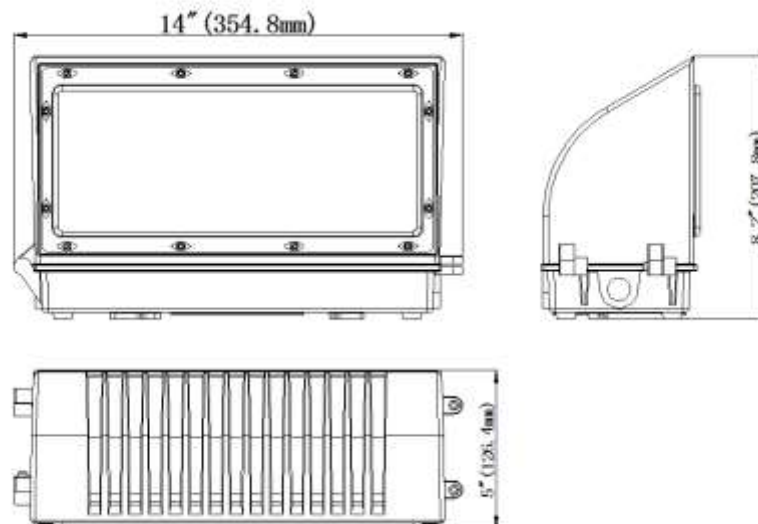

■ Technical Parameters

Type	FWP45W27-XXK-X-X		
Power	45W	Lighting Angle	60*90°
Input Voltage	AC100-277V	LED Brightness Decay	<5%/6000 hrs
PF	>0.95	Working Life	>50000 hrs
Driver Efficiency	>90%	Working Temperature	-30 - +45°C
Luminous Flux	4815 Lm	Storage Temperature	-40 -+80°C
Color Temperature	3000K/4000K/5000K/6500K	Protection Level	Wet Location/IP65
CRI	Ra>80	Cable	Input Connect, No cable

Remark: X=Option code

■ Light Distribution Curve (Clear Lens)

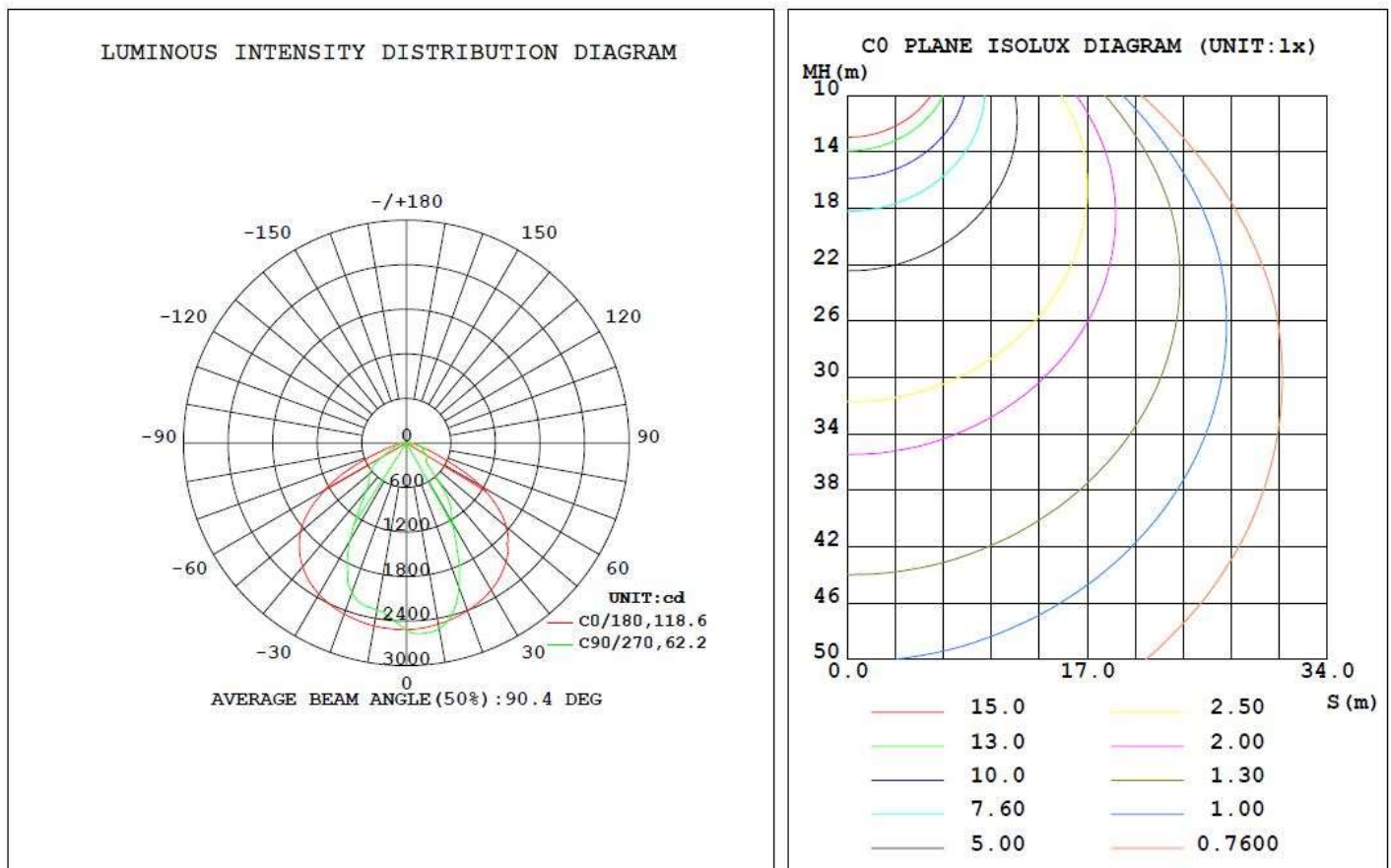

45W LED Full-Cutoff Wall Pack



■ ORDERING INFORMATION:

EXAMPLE: FWP 45W 27-50K-D-P12

FWP	45W	27	50K	D	P12
Product	Power	Voltage	Color Temp	Finish	Control
FWP Full Cutoff Wall Pack	45W(45W) 07W(70W)	27 AC100-277V 48 AC200-480V	30K (3000K) 40K (4000K) 50K (5000K) 65K (6500K) ± 500K	D Dark Bronze W White	P12 120V Photocell P27 277V Photocell

ACES LED reserved the right of changing this datasheet RV1.0